

The following illustrations (pages 1-10) depict graphics projects done for Army doctrinal publication.

Before & After use of PowerPoint to create rendered depth beyond the contour of a vector line:

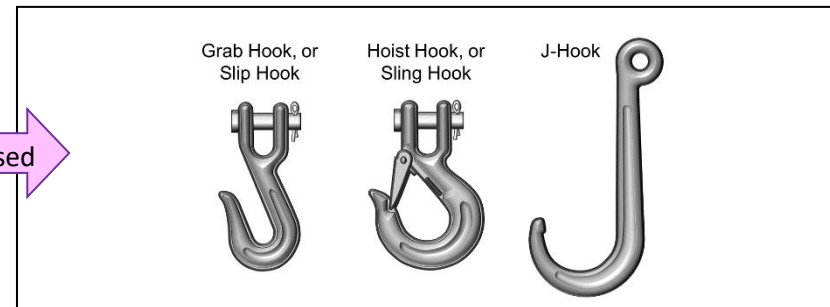

Clarification of procedural sequence through illustration:

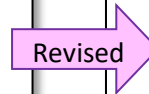
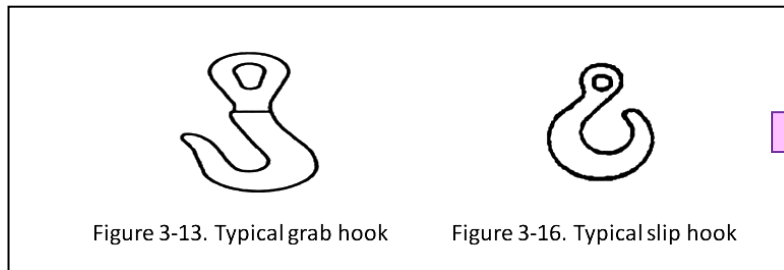
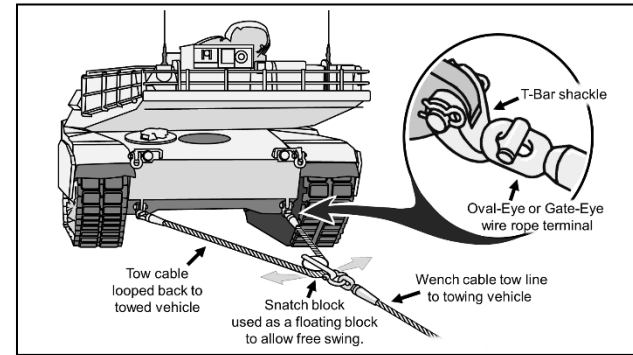
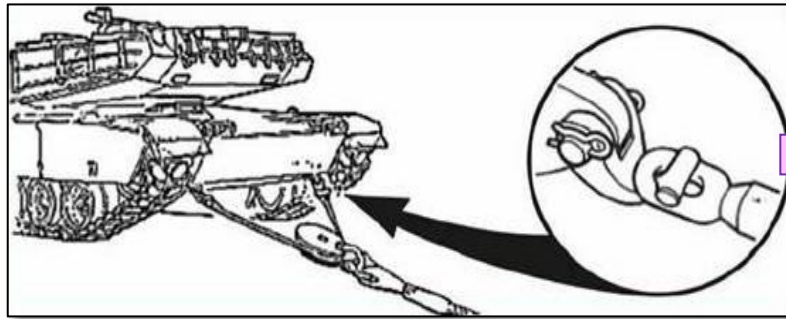
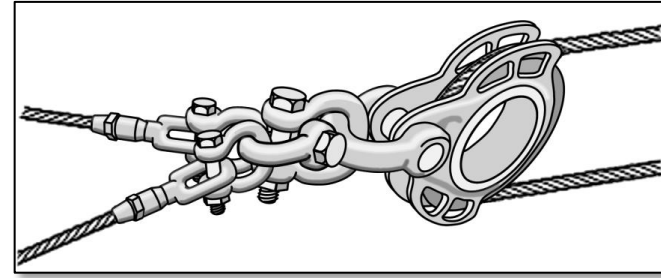
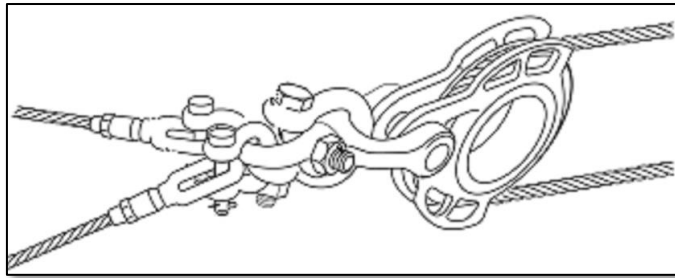

Revised

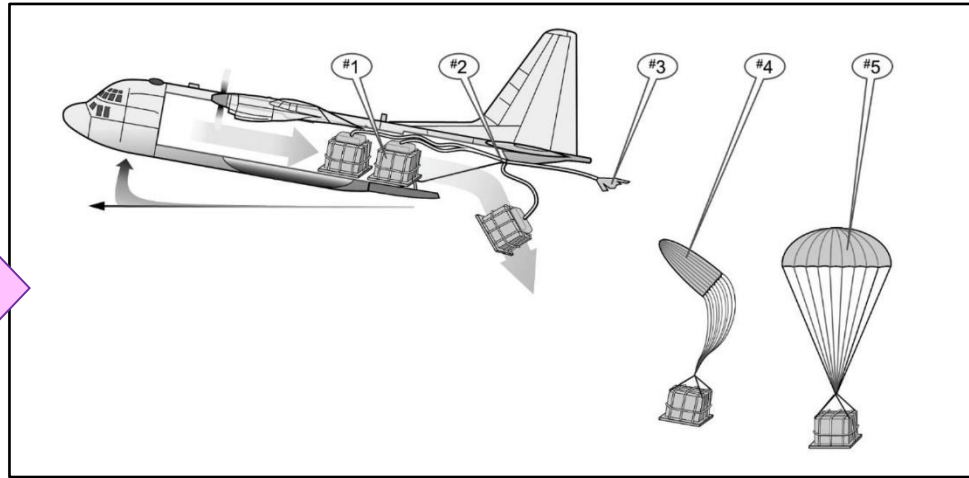

Revised

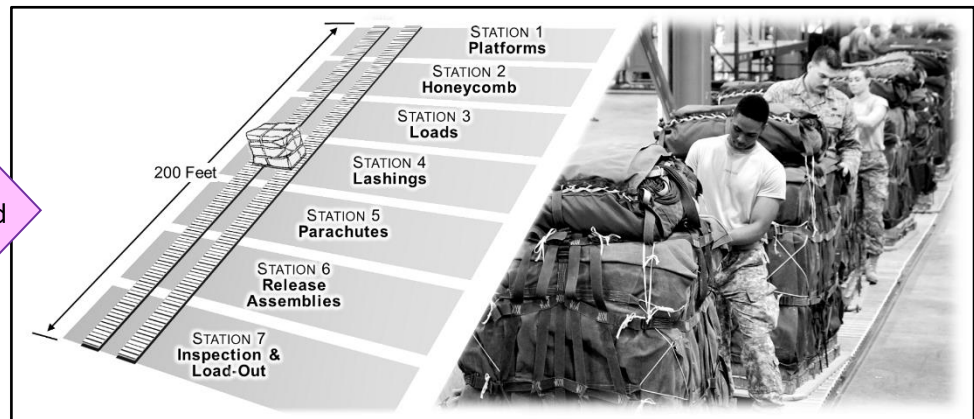

PowerPoint Graphic Image Regeneration Projects

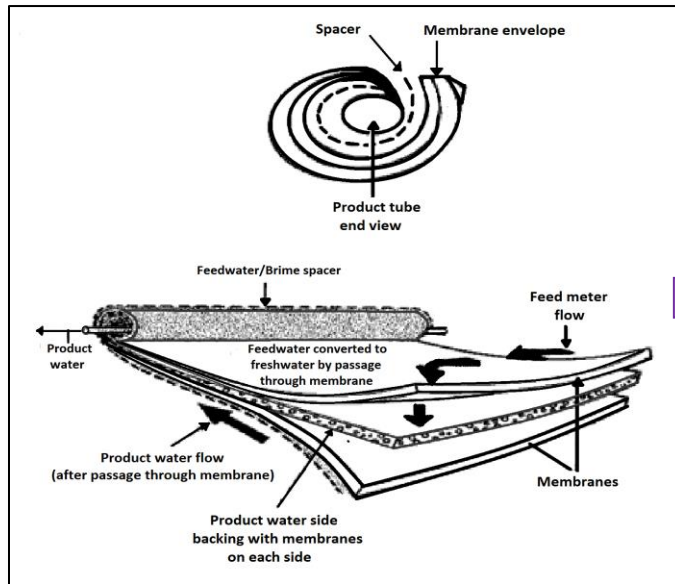

Revised

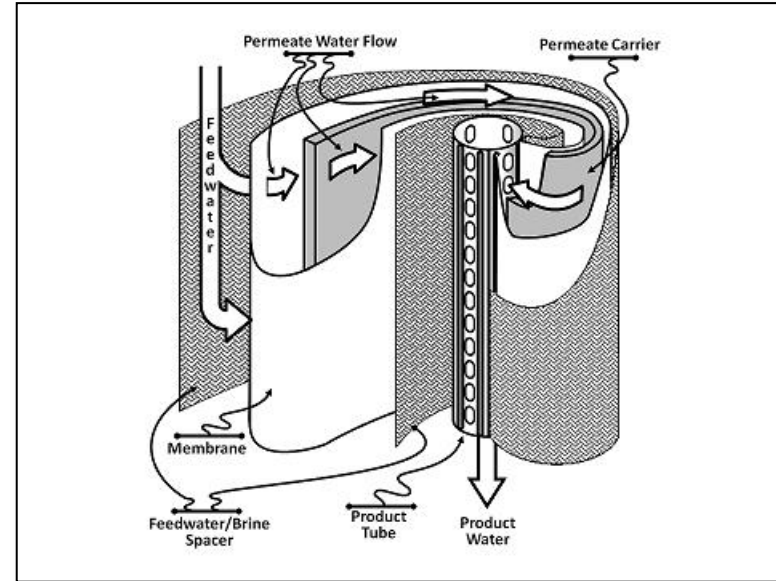

ATP 4-44, Water Supply in Theaters of Operations: Spiral RO Membrane Assembly; before and after.

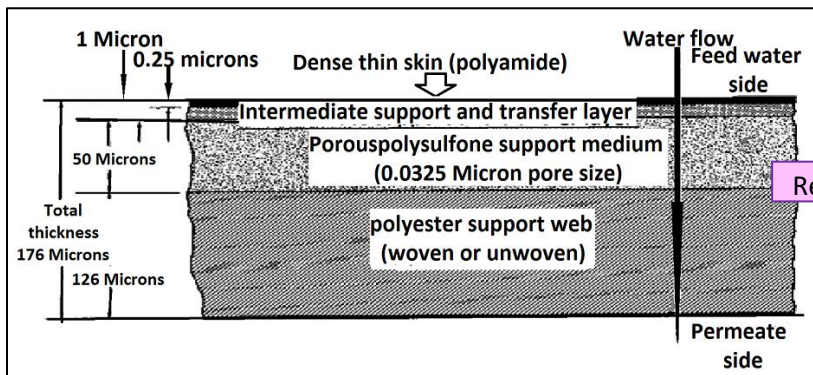

Revised

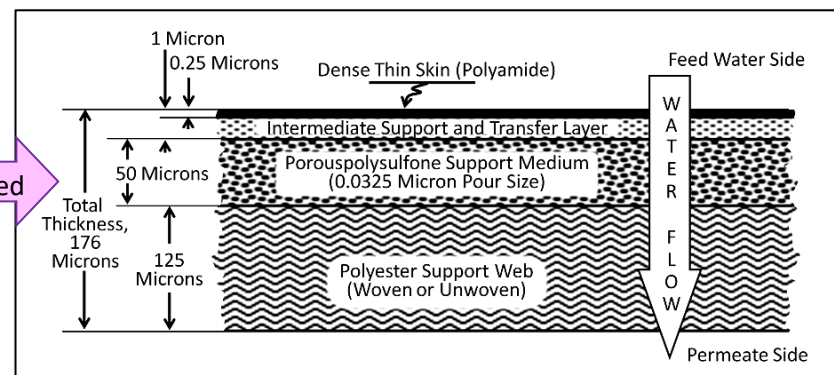

ATP 4-44, Water Supply in Theaters of Operations: RO Membrane Composition; before and after.

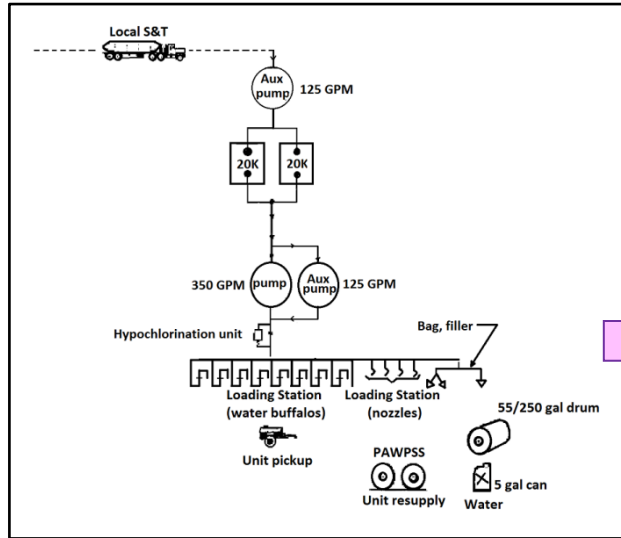

Revised

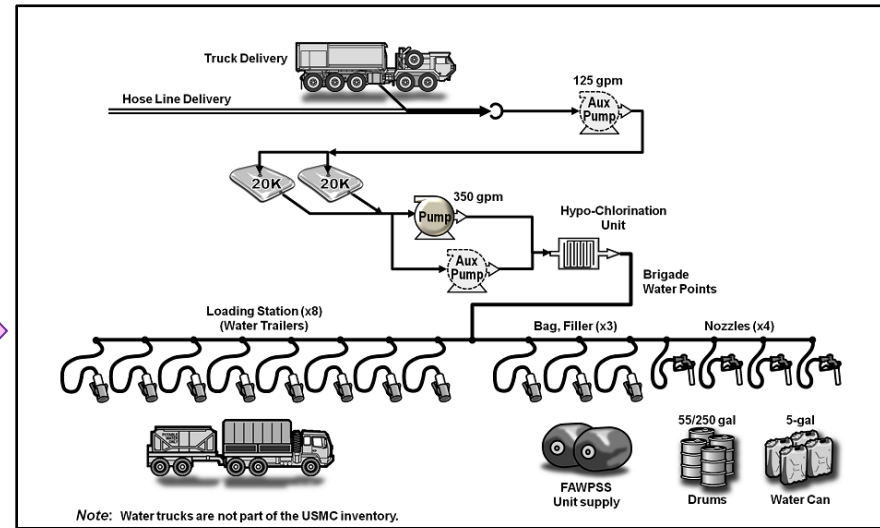

ATP 4-44: 40,000 Gallon water supply point setup; before and after. Notice the ability to create an embossed affect with PowerPoint.

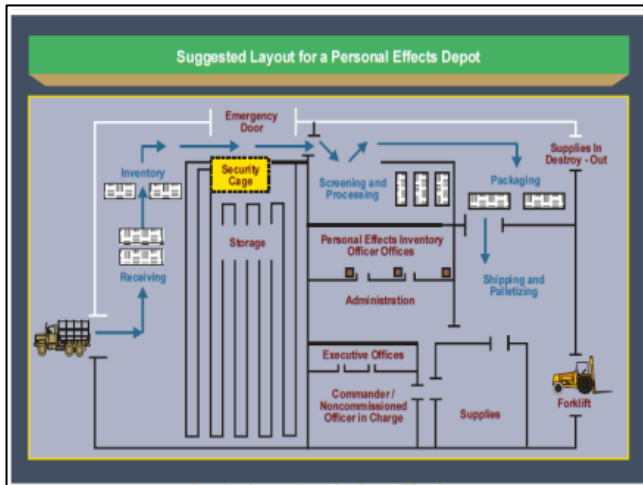

Revised

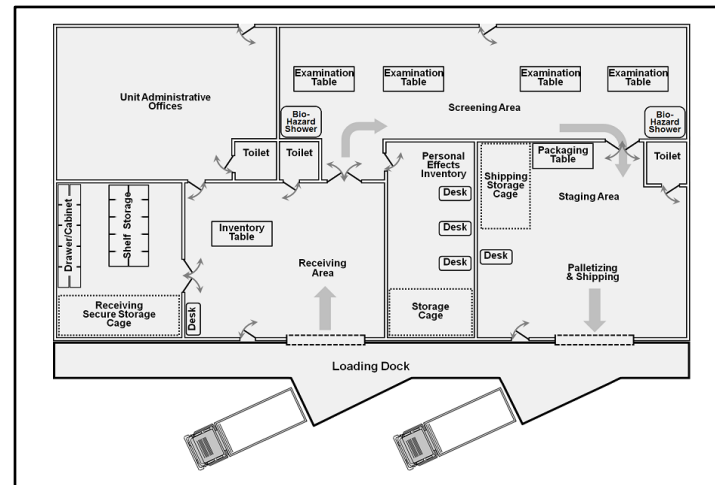

ATP 4-46, Mortuary Affairs Operations: Personal Affects Depot Layout, Visio versus PowerPoint

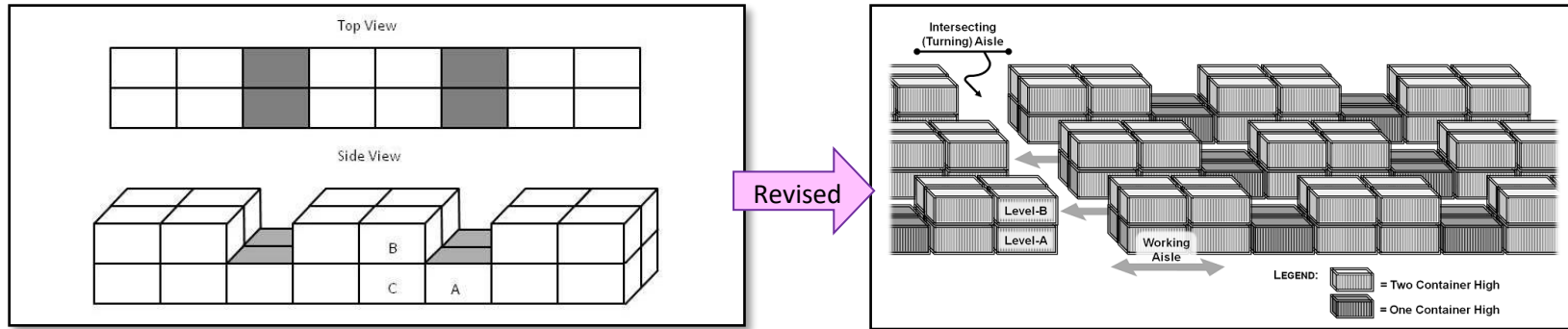

ATP 4-13, Army Intermodal Operations: Container Stacking; before and after with PowerPoint. Notice the realism.

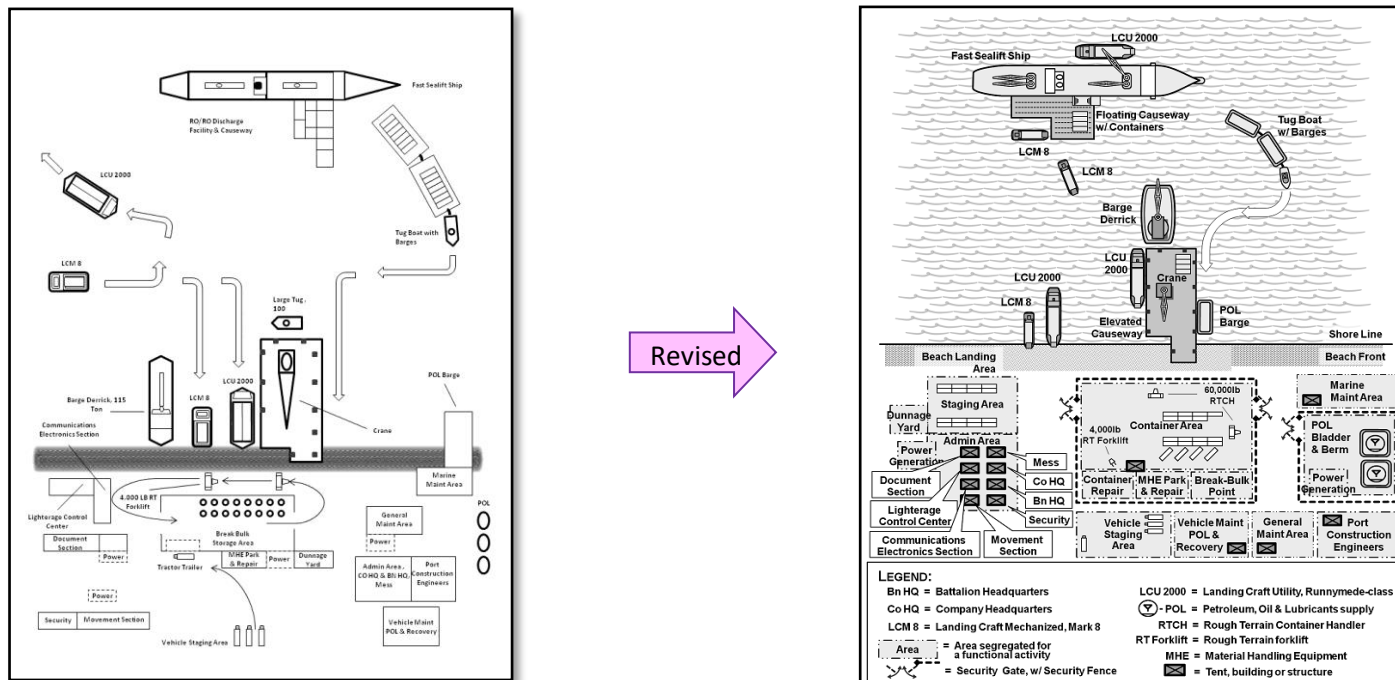

ATP 4-13, Army Intermodal Operations: Logistics Over-The- Shore Operations; before and after with PowerPoint

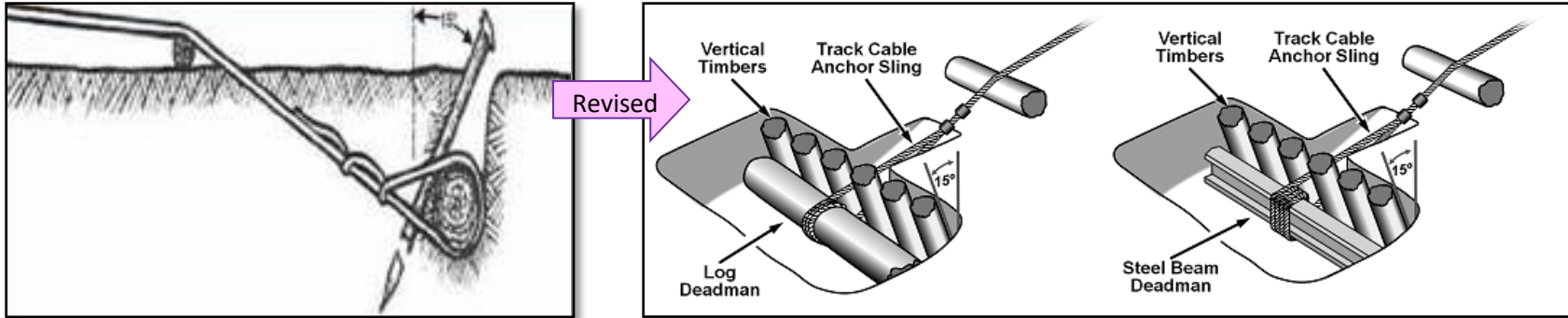

ATP 4-31, Recovery and Battle Damage Assessment and Repair: Log Deadman; before and after. Notice how the use of perspective brings out the engineering capability of its design function.

Before and after, image revisions for ATP 4-41, Atmy Field Feeding operations, on the right and just below.

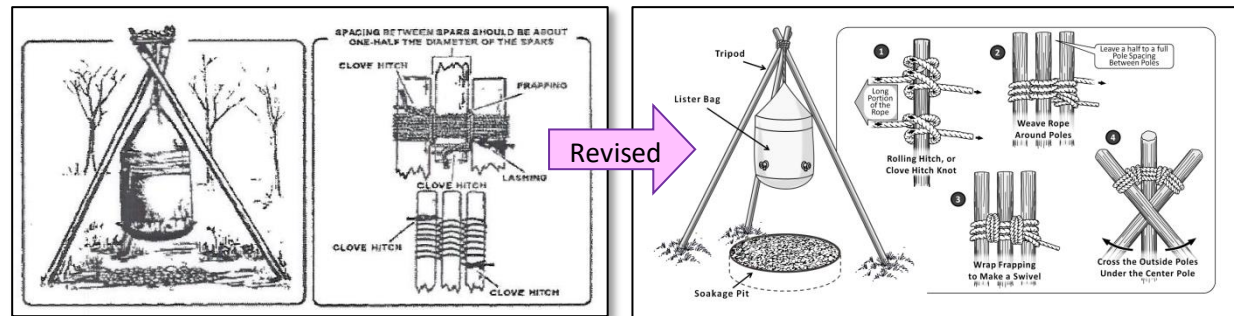
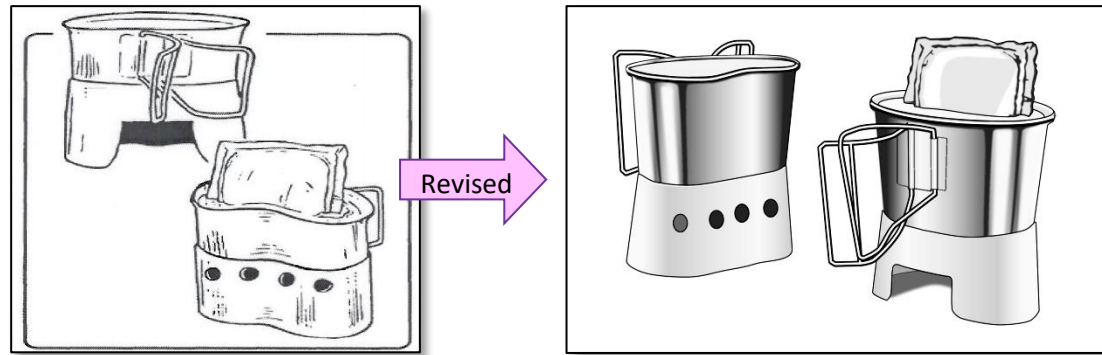

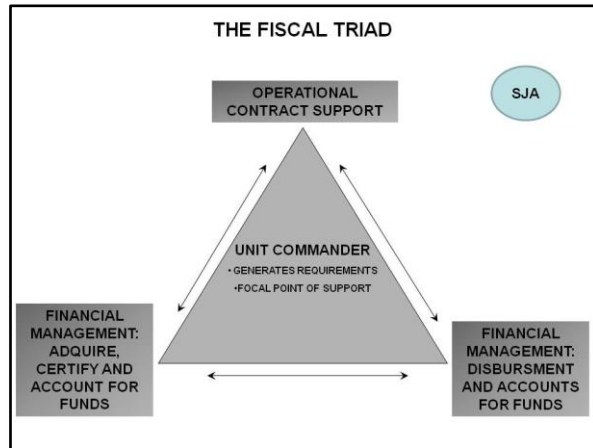

Revised

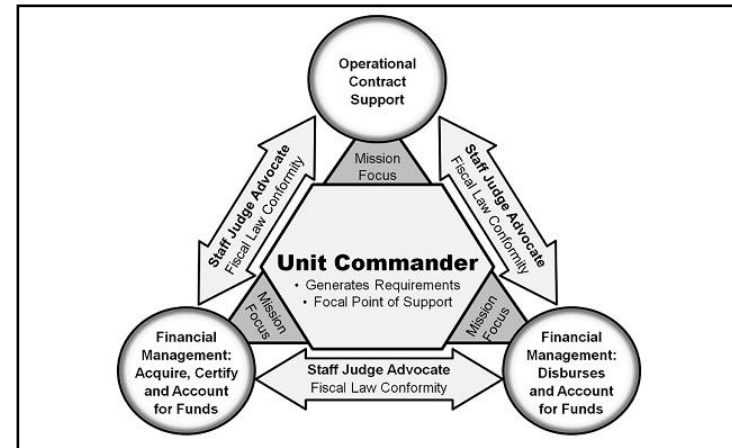

FM 1-06, Financial Management Operations: Fiscal Triad; before and after.

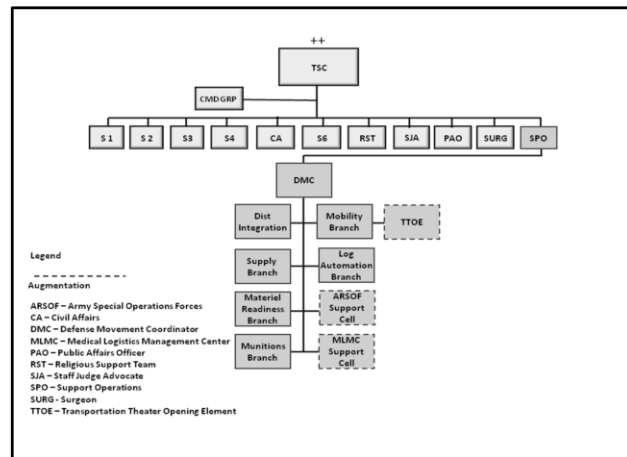

Revised

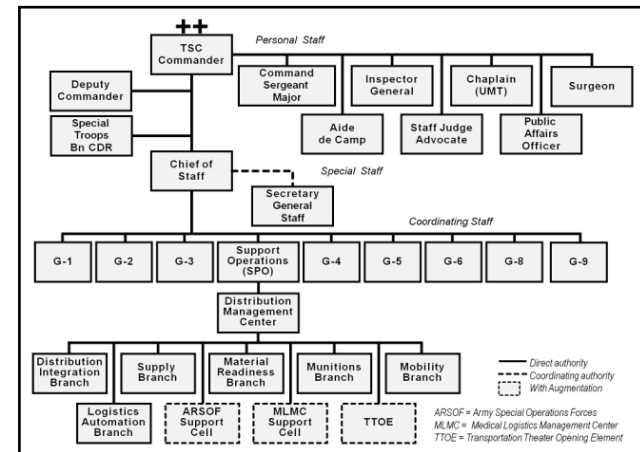

FM 4-01, Army Transportation Operations: Distribution Management Center within the TSC; before and after. Notice the reduction in abbreviations, control of white space, correctness of organizational structure, and uniformity of blocks

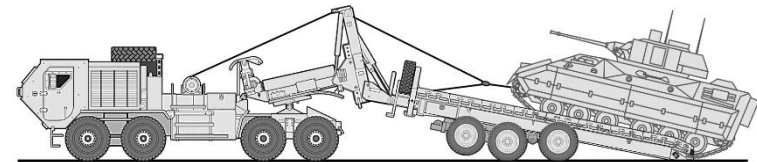
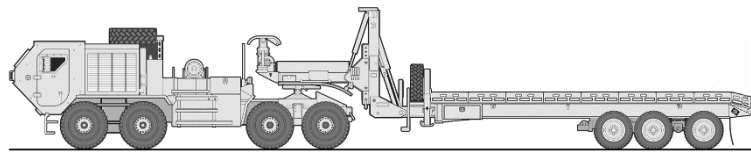
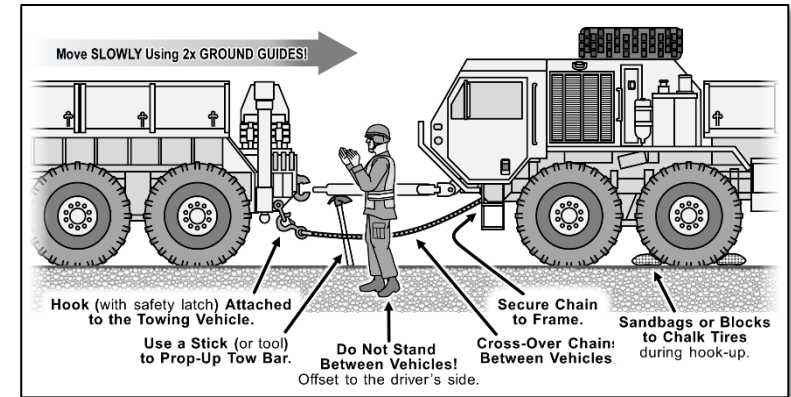
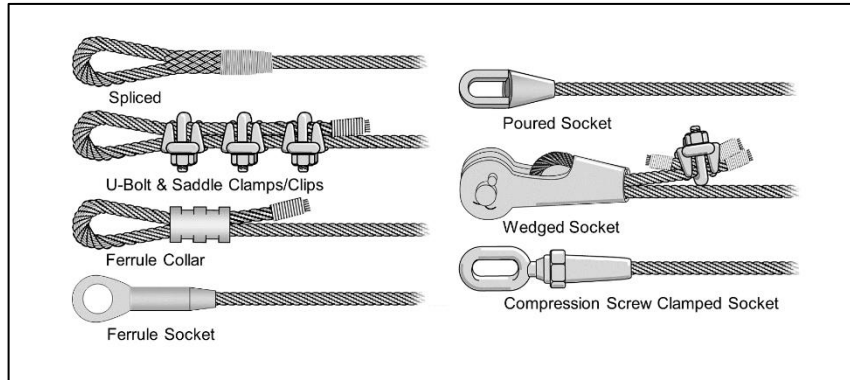

The original image (to the left) was a photocopy from a 1950's manual with text bleedthrough from thin paper. The image (on the right) was recovered using Microsoft Paint and Picture manager.

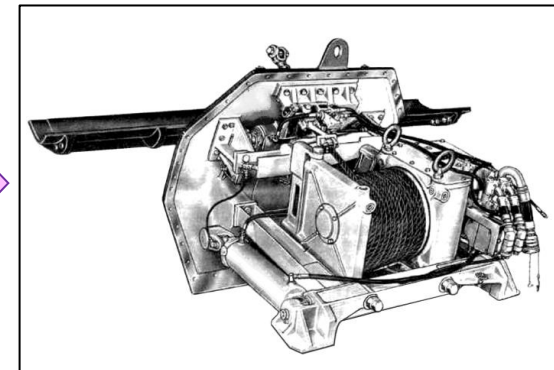
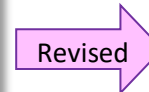
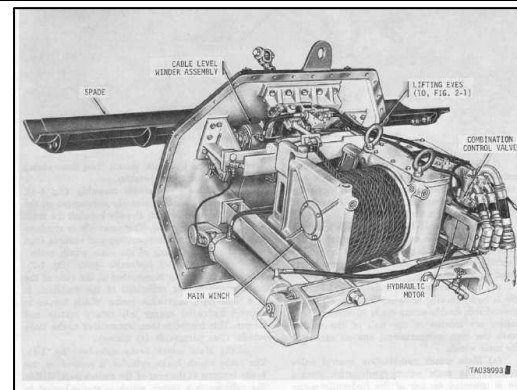



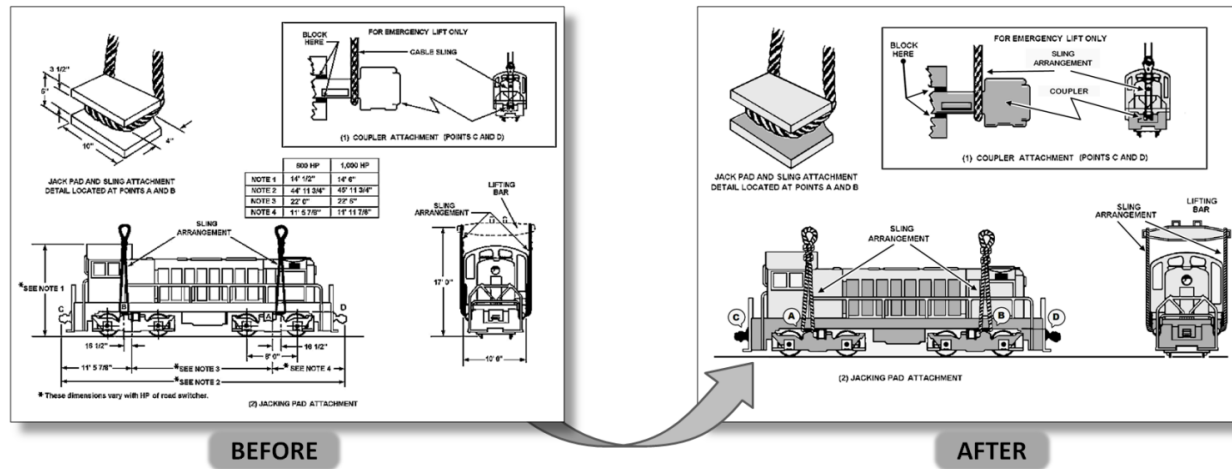

Image enhancement using Microsoft Paint.

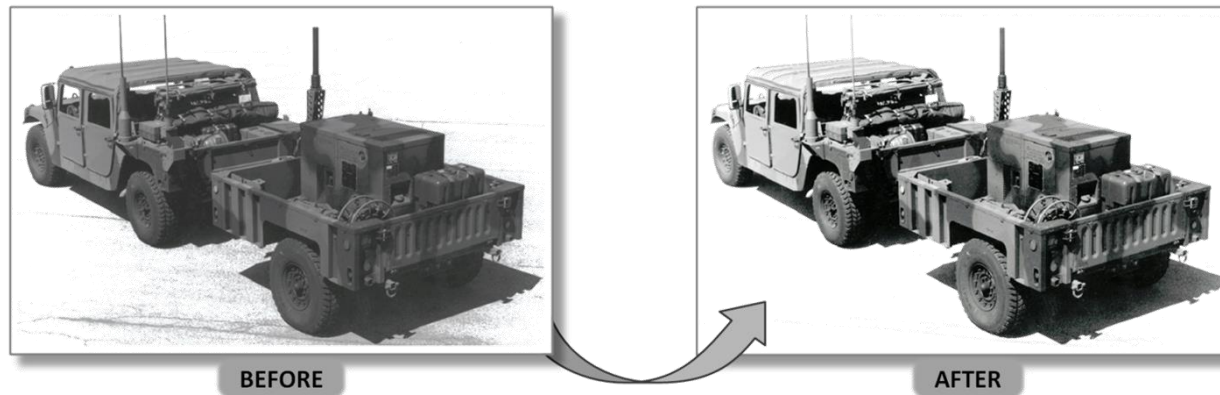
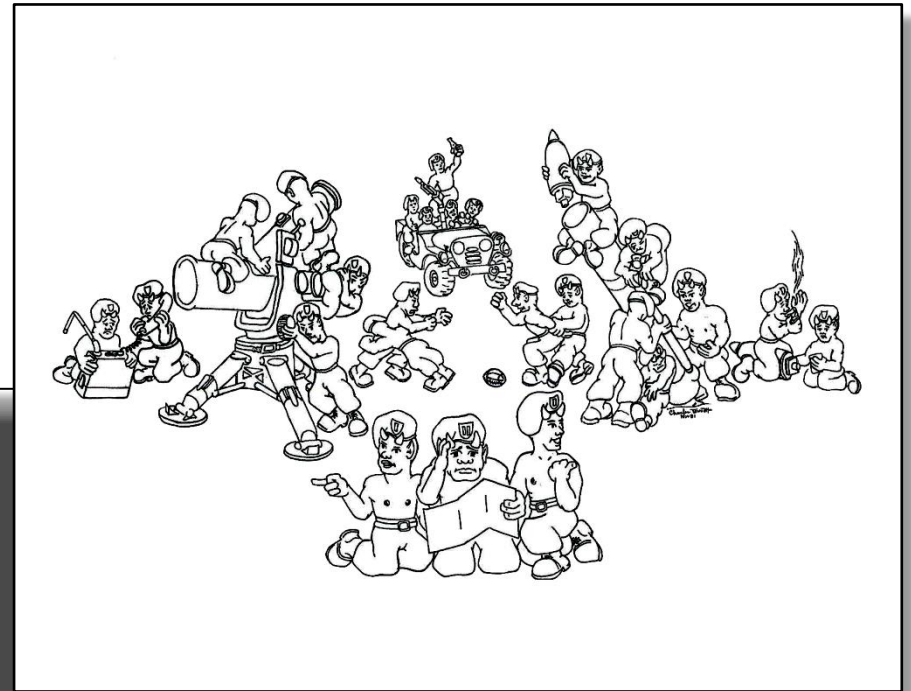
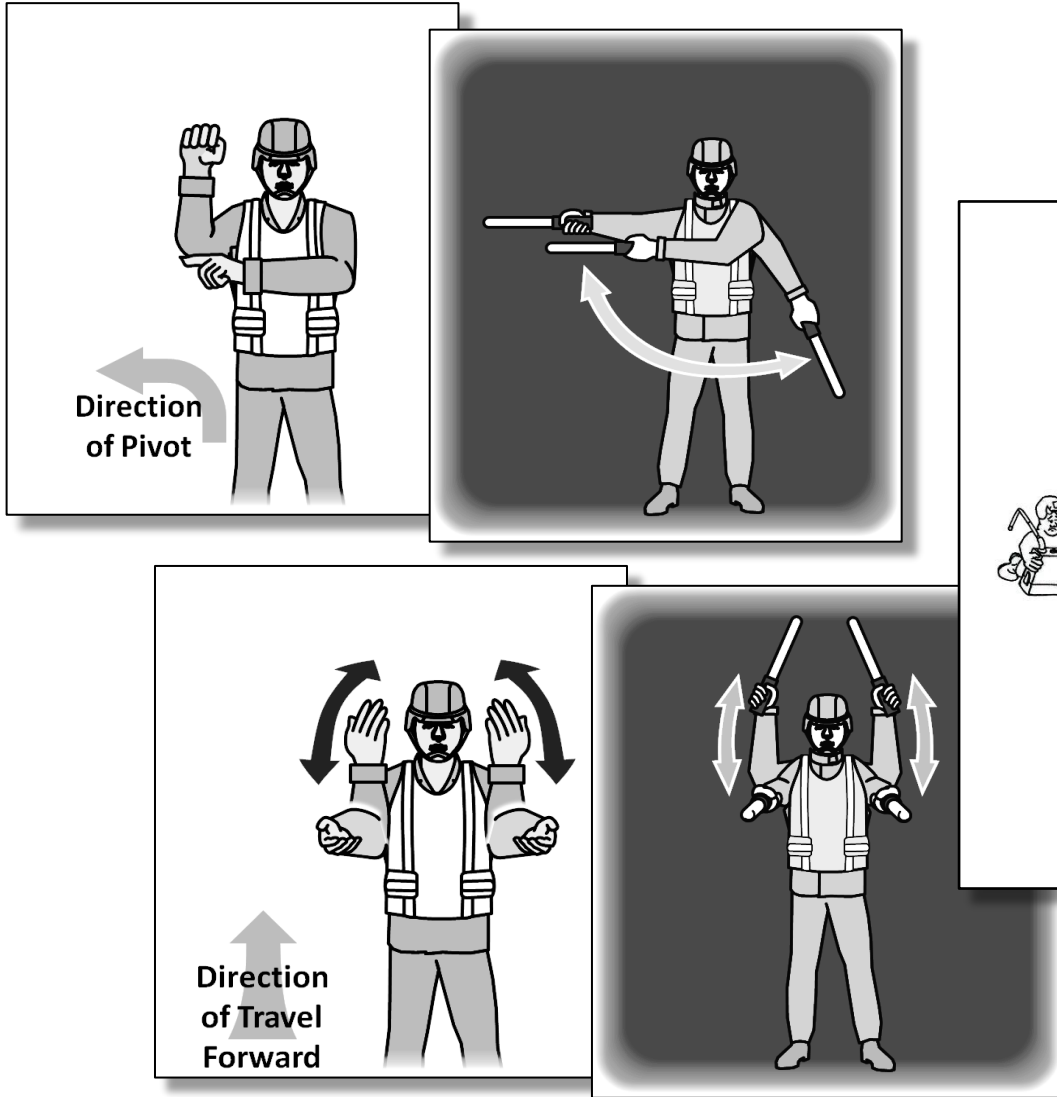
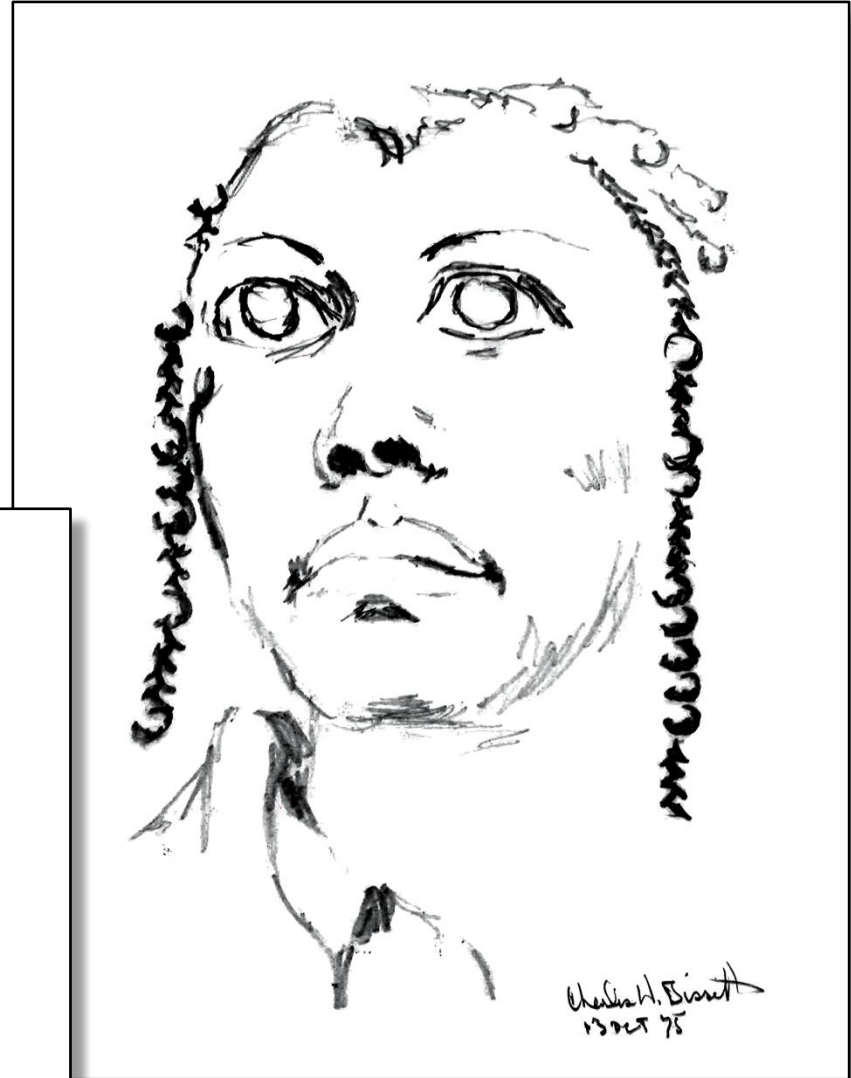
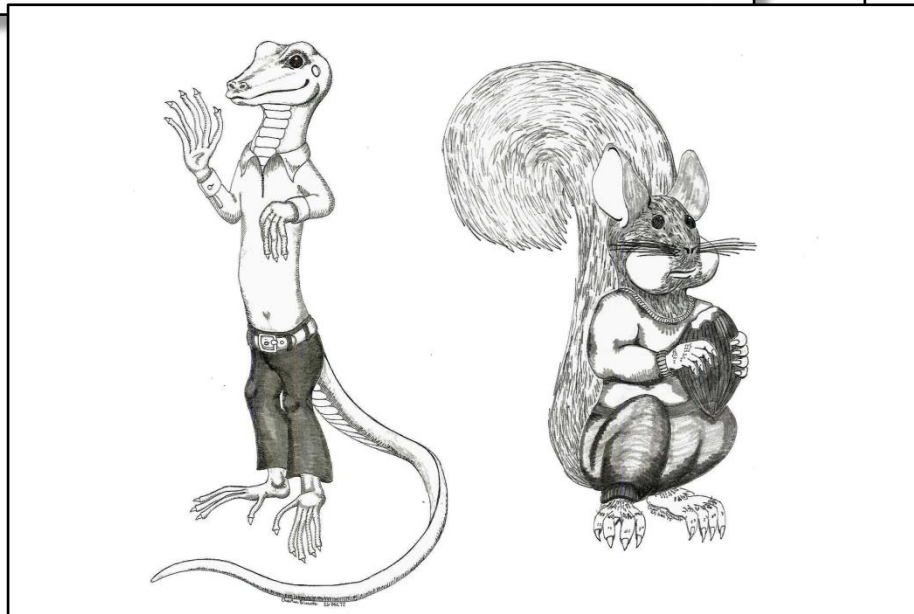
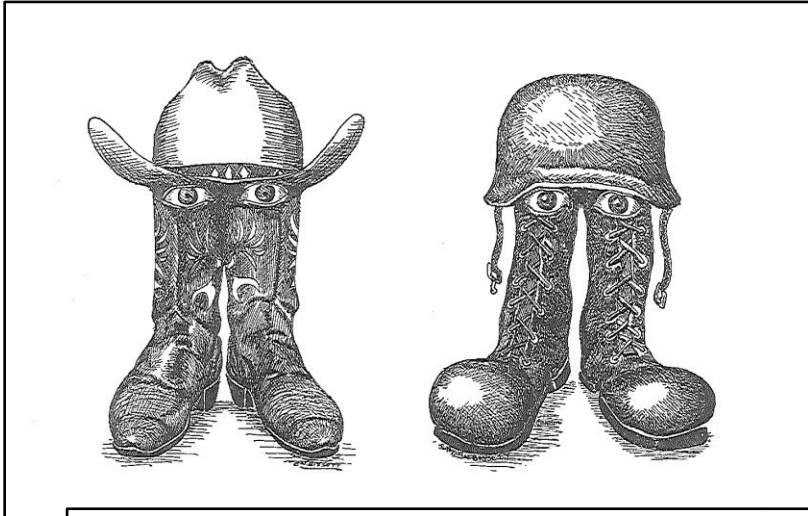

Image enhancement using Microsoft Picture Manager.

Personal Cartooning



Examples of cartoning used for military messages, and for entertainment: PowerPoint on the left; hand drawn on the right.



Hand drawn art projects.